

Article number: 208060271

Description: E+G Sphericalwasher female DIN 6319-28-D-NI  
Stainless Steel 1.4305

## Measures

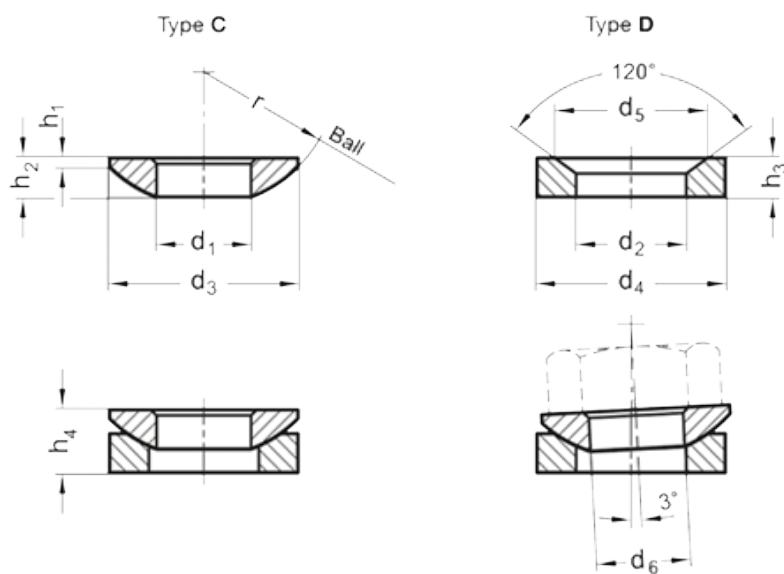

$d_2 = 28.0$

$d_4 = 44$

$d_5 = 37.0$

$d_6 = M24$

$H_3 = 9.5$

$H_4 = 15.2$